

Varenummer: 203180M24200B3T
 Beskrivelse: E+G Justerfod
 GN 31-80-M24-200-B3-T
 Note: T Uden møtrik, spændeflade i bunden

Mål

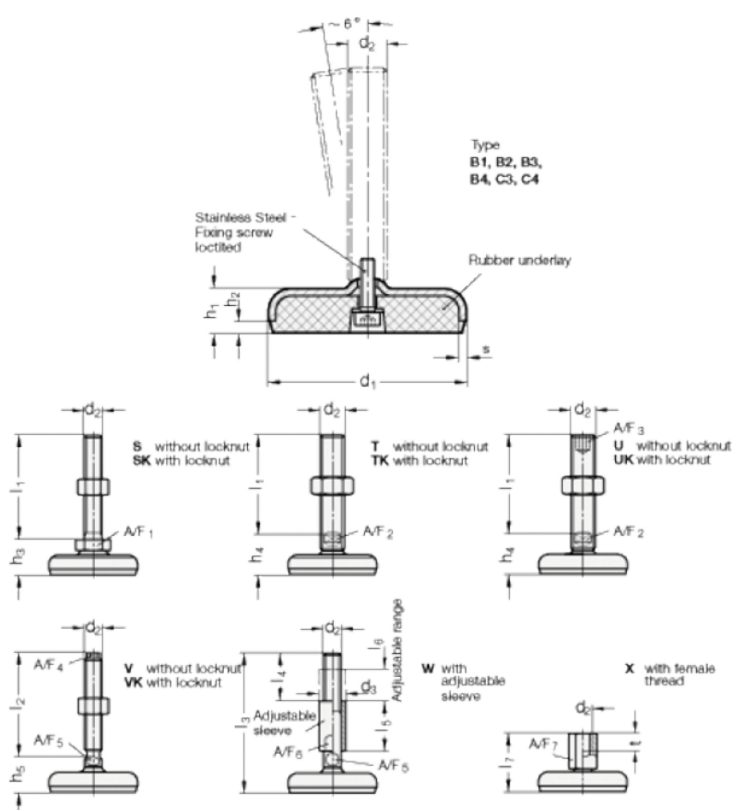

A/F2	= 19
d1	= 80
d2	= 24
h1	= 18
h2	= 5
h4 +4.0/0	= 36
l1	= 200
s	= 3